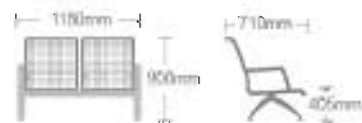
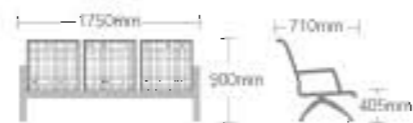
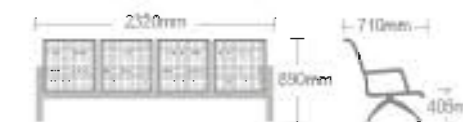

具有现代感的美观得体的造型设计，曲线组合，充满舒适随意自由的感觉，可任意组合，高品位的优雅格局。

Modern beauty ,proper design and composition of curves create a sense of comfort and freedom ,High class elegant structure

GY-B8201

GY-B8301

GY-B8401

Armrests, Legs 扶手、脚

采用铝合金压铸而成，处理后静电喷涂
Adopted aluminum alloy die-casting shape, electrostatic oil spraying after treatment.

Seat, Bracket 座板、支架

采用 1.5 厚冲孔、焊接而成，除锈处理静电喷涂
Adopted 1.5 thick cold rolling punching, welding and joint, rust remove treatment and electrostatic spraying.

Crossbeam 横梁

105 mmx105mmx125mmx2mm 厚冲孔板焊接而成，除锈处理后静电喷涂。
105mmx105mmx125mmx2mm thick cold rolled plate welded and joint, rust remove treatment and electrostatic spraying

洁净、清爽的色调，朴素无华，空间的虚与美会让人心旷神怡。造型简约，协调统一。
 Color makes one feel clean, fresh and simple, emptiness and beauty makes one feel relaxed and joyous.
 Succinct design shows harmonious and unitary

GY-B8501

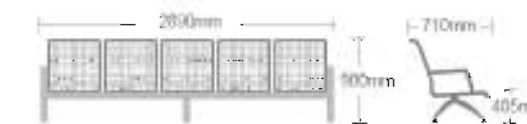
GY-B8501+4

Armrests, Legs
扶手、脚

采用铝合金压铸而成，处理后静电喷涂
 Adopted aluminum alloy die-casting shape, electrostatic oil spraying after treatment.

Seat, Bracket
座板、支架

采用 1.5 厚冲孔冲孔、焊接而成，除锈处理静电喷涂
 Adopted 1.5 thick cold rolling punching, welding and joint, rust remove treatment and electrostatic spraying.

Crossbeam
横梁

105mm x 105mm x 125mm x 2mm 厚冷轧板焊接而成，除锈处理后静电喷涂。
 105mm x 105mm x 125mm x 2mm thick cold rolled plate welded and joint, rust remove treatment and electrostatic spraying.

GY-B8301F

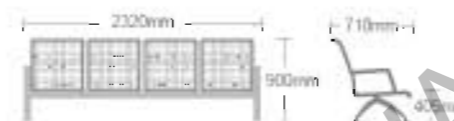
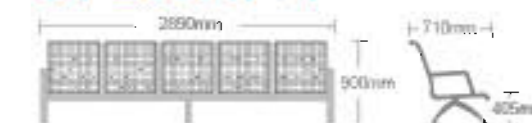
GY-B8401F

GY-B8501F+4

Armrests, Legs 扶手、脚

采用铝合金压铸而成，处理后静电喷涂
Adopted aluminum alloy die-casting shape, electrostatic oil spraying after treatment.

Seat, Bracket 座板、支架

采用 1.5 厚冷轧冲孔、焊接而成，除锈处理静电喷涂
Adopted 1.5 thick cold rolling punching, welding and joint, rust remove treatment and electrostatic spraying.

Crossbeam 横梁

105 mmx 105mm x 125mm x 2mm 厚冷轧板焊接而成，除锈处理后静电喷涂。
105mmx105mmx125mmx2mm thick cold rolled plate welded and joint, rust remove treatment and electrostatic spraying



GY-D8301F-1

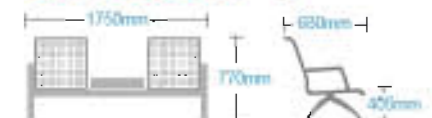

Armrests, Legs
扶手、脚

采用深拉钢板冲压、焊接而成，除锈处理后静电喷涂
Adopted deep drawing steel stamping, welding and joint, rust remove treatment and electrostatic spraying.

Seat, Bracket
座板、支架

采用 1.5 厚冷轧冲孔、焊接而成，除锈处理后静电喷涂
Adopted 1.5 thick cold rolling punching, welding and joint, rust remove treatment and electrostatic spraying.

Crossbeam
横梁

105 mm x 105 mm x 125 mm x 2 mm 厚冷轧板焊接而成，除锈处理后静电喷涂。
105 mm x 105 mm x 125 mm x 2 mm thick cold rolled plate welded and joint, rust remove treatment and electrostatic spraying

新理性主义与国际风格的完美结合，美学与制造工艺浑然天成。
Perfect combination of neorationalism and international style, integration of aesthetics and craftsmanship

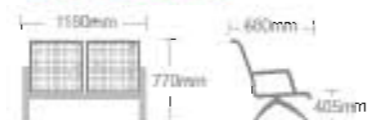
GY-C8201

WANROOEMED

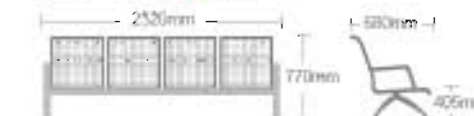
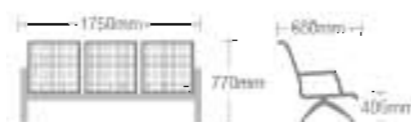
GY-C8401

GY-C8301

Armrests, Legs
扶手、脚

采用深拉钢板冲压、焊接而成，除锈处理后静电喷涂
Adopted deep drawing steel stamping, welding and joint, rust remove treatment and electrostatic spraying.

Seat, Bracket
座板、支架

采用 1.5 厚冷轧冲孔、焊接而成，除锈处理后静电喷涂
Adopted 1.5 thick cold rolling punching, welding and joint, rust remove treatment and electrostatic spraying.

Crossbeam
横梁

105mmx105mmx125mmx2mm 厚冷轧板焊接而成，除锈处理后静电喷涂。
105mmx105mmx125mmx2mm thick cold rolled plate welded and joint, rust remove treatment and electrostatic spraying

独特的材质组合，素雅的色彩搭配、流畅明快的线面结合，一切尽是巧妙心思的流露，展现无限现代美感。

unique material combination simple color matching up smooth bright line and side coherence shows all the ingenious idea and endless modern beauty

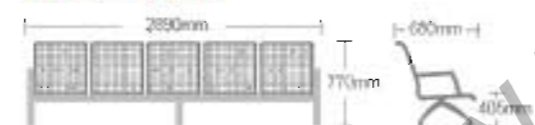
GY-C8501

GY-C8501+4

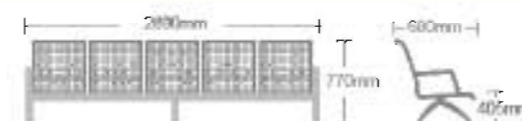
Adopted aluminum alloy die-casting shape, electrostatic oil spraying after treatment. Adopted 1.5 thick cold rolling punching, welding and joint, rust remove treatment and electrostatic spraying. 105x105x125x2mm thick cold rolled plate welded and joint, rust remove treatment and electrostatic spraying.



Armrests, Legs 扶手、脚

采用深拉钢板冲压、焊接而成，除锈处理后静电喷涂
 Adopted deep drawing steel stamping, welding and joint, rust remove treatment and electrostatic spraying

Seat, Bracket 座板、支架

采用 1.5 厚冲孔穿孔、焊接而成，除锈处理后静电喷涂
 Adopted 1.5 thick cold rolling punching, welding and joint, rust remove treatment and electrostatic spraying.

Crossbeam 横梁

105mm x 105mm x 125mm x 2mm 厚冲孔板焊接而成，除锈处理后静电喷涂。
 105mm x 105mm x 125mm x 2mm thick cold rolled plate welded and joint, rust remove treatment and electrostatic spraying

极富创意的结构设计已另人叹为观止，在制作工艺上更值得您细细品味，从细节中您亦可见到产品的品质与品位。

It is surprised to have such structure designed, And the technology is worth while being appropriated, From the details, you can find out the quality and graceful taste of products.

GY-C8301F

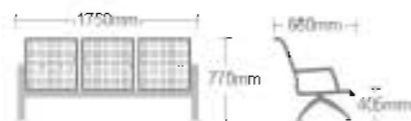

GY-C8401F

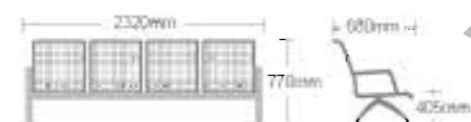

GY-C8501F

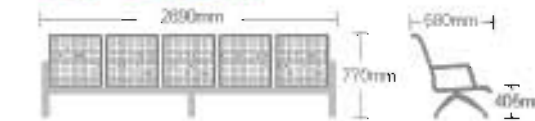

Armrests, Legs 扶手、脚

采用深拉钢板冲压、焊接而成，除锈处理后静电喷涂
Adopted deep drawing steel stamping, welding and joint, rust remove treatment and electrostatic spraying.

Seat, Bracket 座板、支架

采用1.5厚冷轧冲孔、焊接而成，除锈处理后静电喷涂
Adopted 1.5 thick cold rolling punching, welding and joint, rust remove treatment and electrostatic spraying.

Crossbeam 横梁

105mm x 105mm x 125mm x 2mm 厚冷轧板焊接而成，除锈处理后静电喷涂。
105mm x 105mm x 125mm x 2mm thick cold rolled plate welded and joint, rust remove treatment and electrostatic spraying.

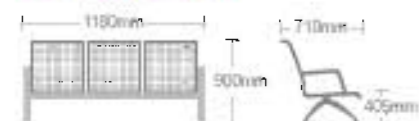
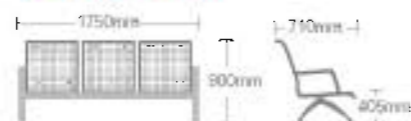
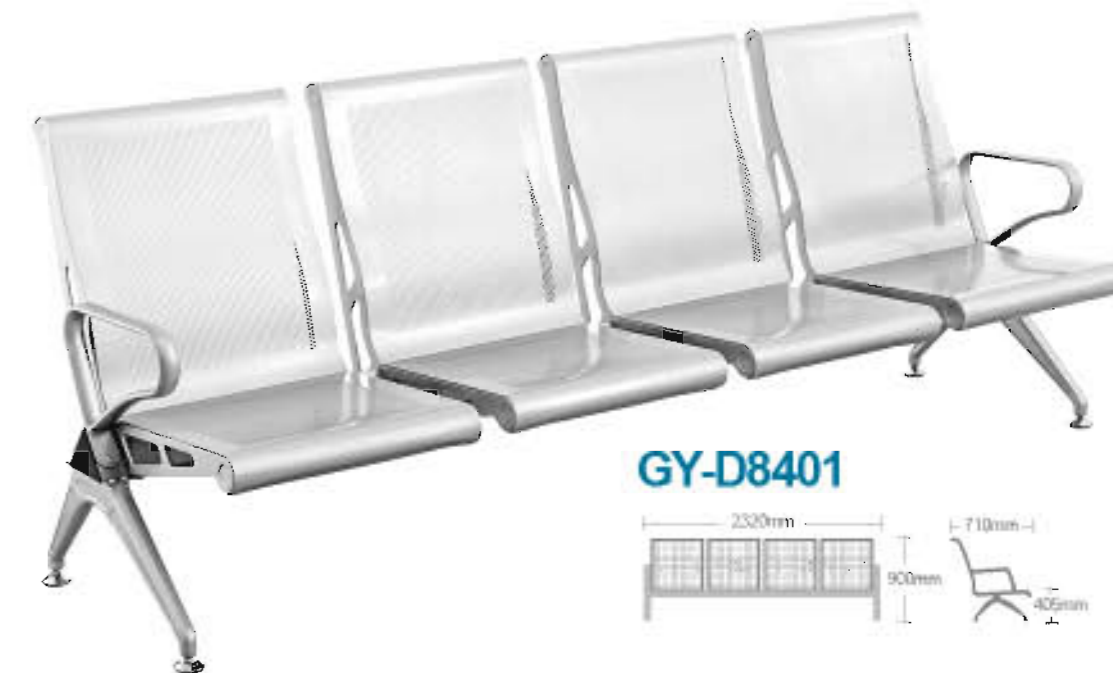
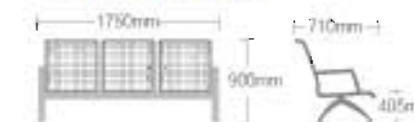
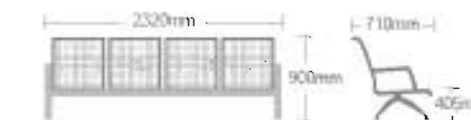
GY-D8201

GY-D8301

GY-D8301F

GY-D8401

Armrests, Legs
扶手、脚

采用深拉钢板冲压、焊接而成，除锈处理后静电喷涂
Adopted deep drawing steel stamping, welding and joint, rust remove treatment and electrostatic spraying

Seat, Bracket
座板、支架

采用 1.5 厚冲孔、焊接而成，除锈处理后静电喷涂
Adopted 1.5 thick cold rolling punching, welding and joint, rust remove treatment and electrostatic spraying

Crossbeam
横梁

105mmx105mmx125mmx2mm 厚冲孔板焊接而成，除锈处理后静电喷涂。
105mmx105mmx125mmx2mm thick cold rolled plate welded and joint, rust remove treatment and electrostatic spraying

简约主义就是把设计简化到它的本质，强调它的内在的魅力，在这种充满冷调的现代与未来交织的情境中，会由简单而产生出理性、秩序和专业感。

The doctrine of simplify the design to the essence and emphasize its inside fascination. In this cold-tone environment interweaving the modern and the future, simplicity will produce rationality, order and professional sense

简约主义就是把设计简化到它的本质，强调它的内在的魅力，在这种充满冷调的现代与未来交织的情境中，会由简单而产生出理性、秩序和专业感。

The doctrine of simplify the design to the essence and emphasize its inside fascination. In this cold-tone environment interweaving the modern and the future, simplicity will produce rationality, order and professional sense.



WANROOEMED

GY-D8501+4

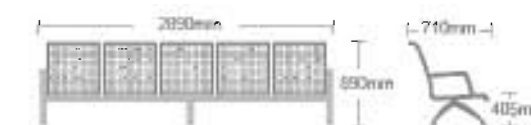

GY-D8501

Simple and honest feeling comes from thick colors, from substantial and abstract combination of square, rectangle, circle and ideas, which inspires your expectation in a flash. Every design is made to suit each user. Usage and comfort are two things which will always be considered.

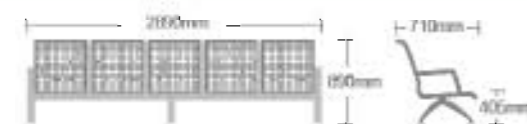

Armrests, Legs
扶手、脚

采用深拉钢板冲压、焊接而成，除锈处理后静电喷涂
Adopted deep drawing steel stamping, welding and joint, rust remove treatment and electrostatic spraying.

Seat, Bracket
座板、支架

采用 1.5 厚冷扎冲孔、焊接而成，除锈处理后静电喷涂
Adopted 1.5 thick cold rolling punching, welding and joint, rust remove treatment and electrostatic spraying.

Crossbeam
横梁

105mmx105mmx125mmx2mm 厚冷扎板焊接而成，除锈处理后静电喷涂。
105mmx105mmx125mmx2mm thick cold rolled plate welded and joint, rust remove treatment and electrostatic spraying.



GY-BS01

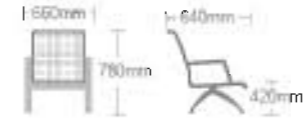

GY-BS02

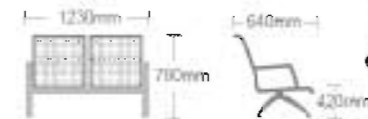

以人为本的设计理念, 简约的风格, 精湛的工艺, 大胆而富有创意的环保选材, 演绎出惊讶脱俗的时尚产品, 让你感受到生活的优美旋律。

Human-oriented design concept, simple style, exquisite techniques, bold and environment-friendly materials, express elegant and refined trendy products, and bring to you the wonderful tune of life

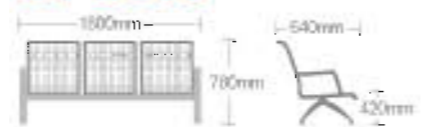
GY-BS03

Armrests. legs. seat. side strip
扶手、脚、坐板、边条

采用不锈钢板冲压、焊接而成, 能防止永久性不生锈。
Through stamping and welding stainless steel plate can ensure a permanent resistant to rust

Crossbeam
横梁

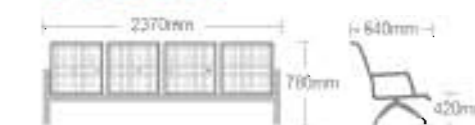
采用 40x80x1.8mm 厚钢管, 喷涂空调产外漆粉处理。
Uses the 40 x 80 x 1.8 mm thick steel pipe, Spray soating an conditioning outdoors paint powder processing

GY-BS04

GY-BS05

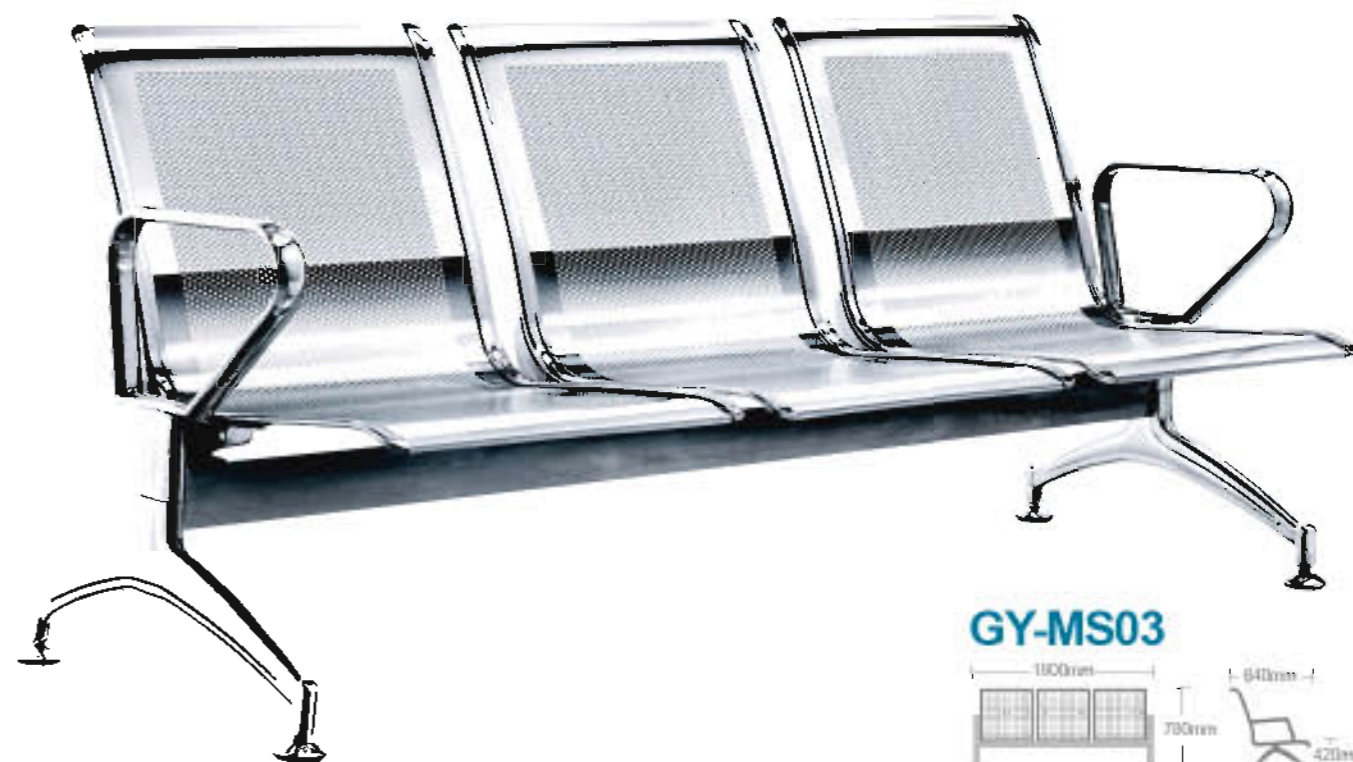
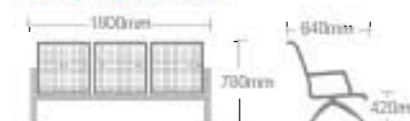
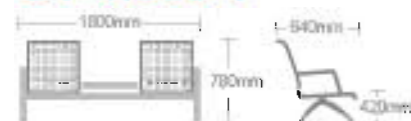

GY-MS02

GY-MS03

GY-MS03-1

Armrests, legs, seat, side strip
扶手、脚、坐板、边条

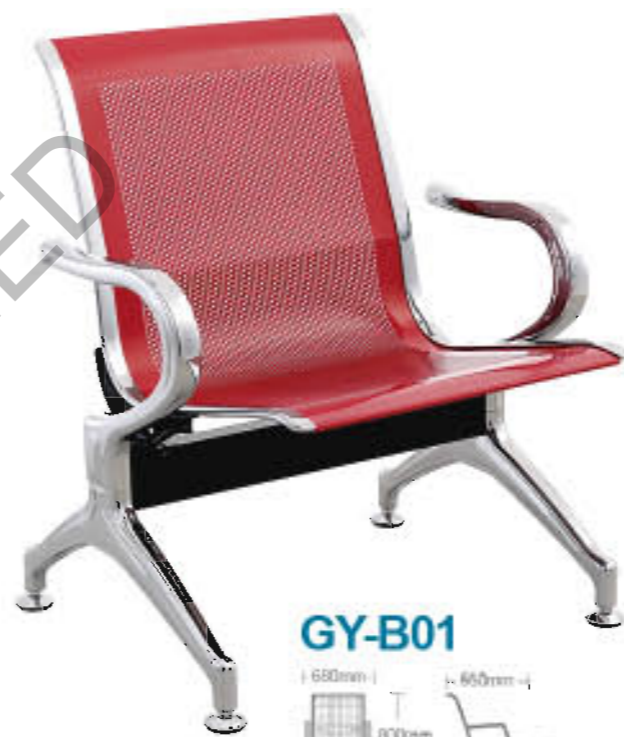
采用不锈钢板冲压、焊接而成，确保永久性不生锈。
Through stamping and welding stainless steel plate can ensure a permanent resistant to rust.

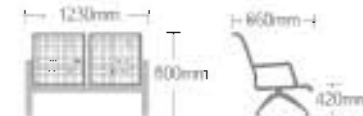
Crossbeam
横梁

采用40x80x1.8mm厚钢管，喷涂空调产外漆粉处理。
Uses the 40x80x1.8mm thick steel pipe, Spray coating an conditioning outdoors paint powder processing.

GY-B01

GY-B02

This is a style, an expansion and unique taste, close to life and all-purpose. The result of creation is rebirth, just like phoenix, with lines of sight and beam dancing like musical notes. Just feel and enjoy it. 这是一种风格，这是一种延伸，也是一种别致的格调。可以无所不能，可以更贴近生活，创造的结果是死尽全部的重生，视线和光线的落差是每个休止符在跳跃，无限升华，无限体验。

时代的需要，时尚的体现。简洁、舒适、优美，不失活泼。
Requirement of the times, reflection of fashion, concise, comfortable and elegant, fit to the human body

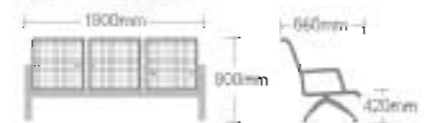
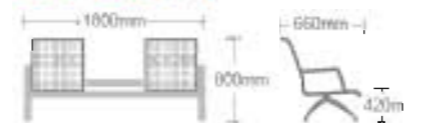
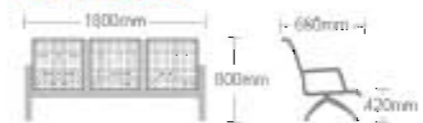
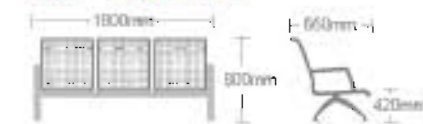
GY-B03

GY-B03-1

GY-B03F

GY-B03F2

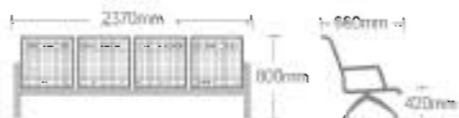
The creative inspiration and wisdom is the source of trend leading steady and elegant appearance comes with endless intelligence, noble and graceful quality fully demonstrates free and unrestrained styles.
引领时代之先，来自创新的灵智，精益求精的外表内蕴无尽智慧，尊贵典雅气质尽显自如洒脱。



GY-B04



GY-B04F

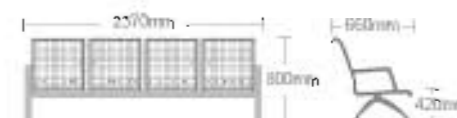

GY-B04+3

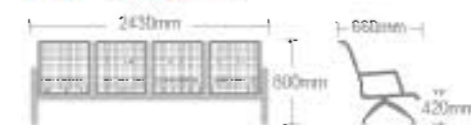

GY-B04F+3

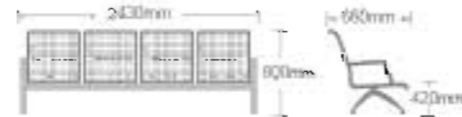

简洁、明快的线条，虚实的对比，构成完美的结合体，内蕴气质不露自显，时尚的体现。

Lucid and lively lines, contrast of abstract and concrete from perfect combination. Naturally revealed inner style is modern reflection.

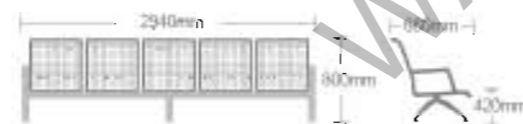
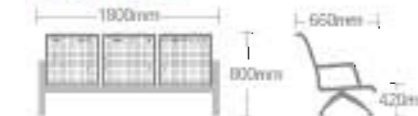
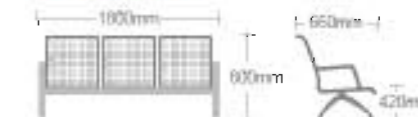

GY-B05

GY-E03

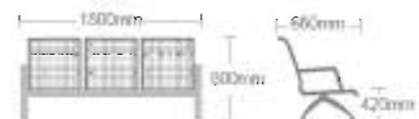
GY-D03

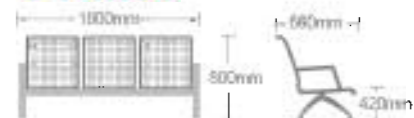

GY-A03



GY-M03



GY-K03

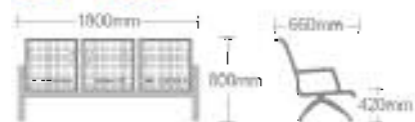

GY-M03F

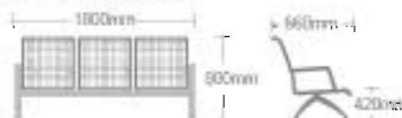

思想顿悟时节，传统思维汲取灵感迸发。一个眼色，即心领神会导致一种完美的合作，经得起岁月的珍藏。

In the time of free thoughts, to seek inspiration in tradition, and the understands tacitly with a hint of a tip, leading to one kind of perfect cooperation with years to enjoy

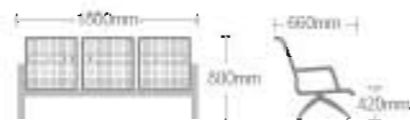
GY-LB03

协从间，精准契合；分秒里，效率呈现。时间，因此而凝固，因此而恒长。因为需要，才会创造，这是完美的原动力。

Cooperation and harmony; The efficiency is a matter of seconds, the time is therefore compact, is therefore permanent. The need is the force that creates the perfection.

WANROOEMED

GY-LB04

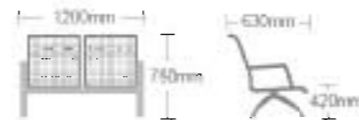
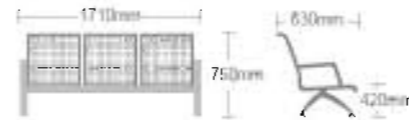
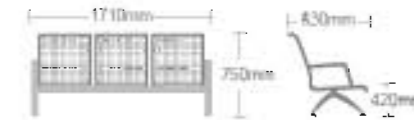
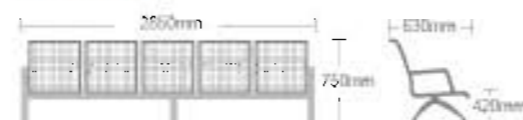

GY-F01

GY-F02

GY-F03

GY-F03F

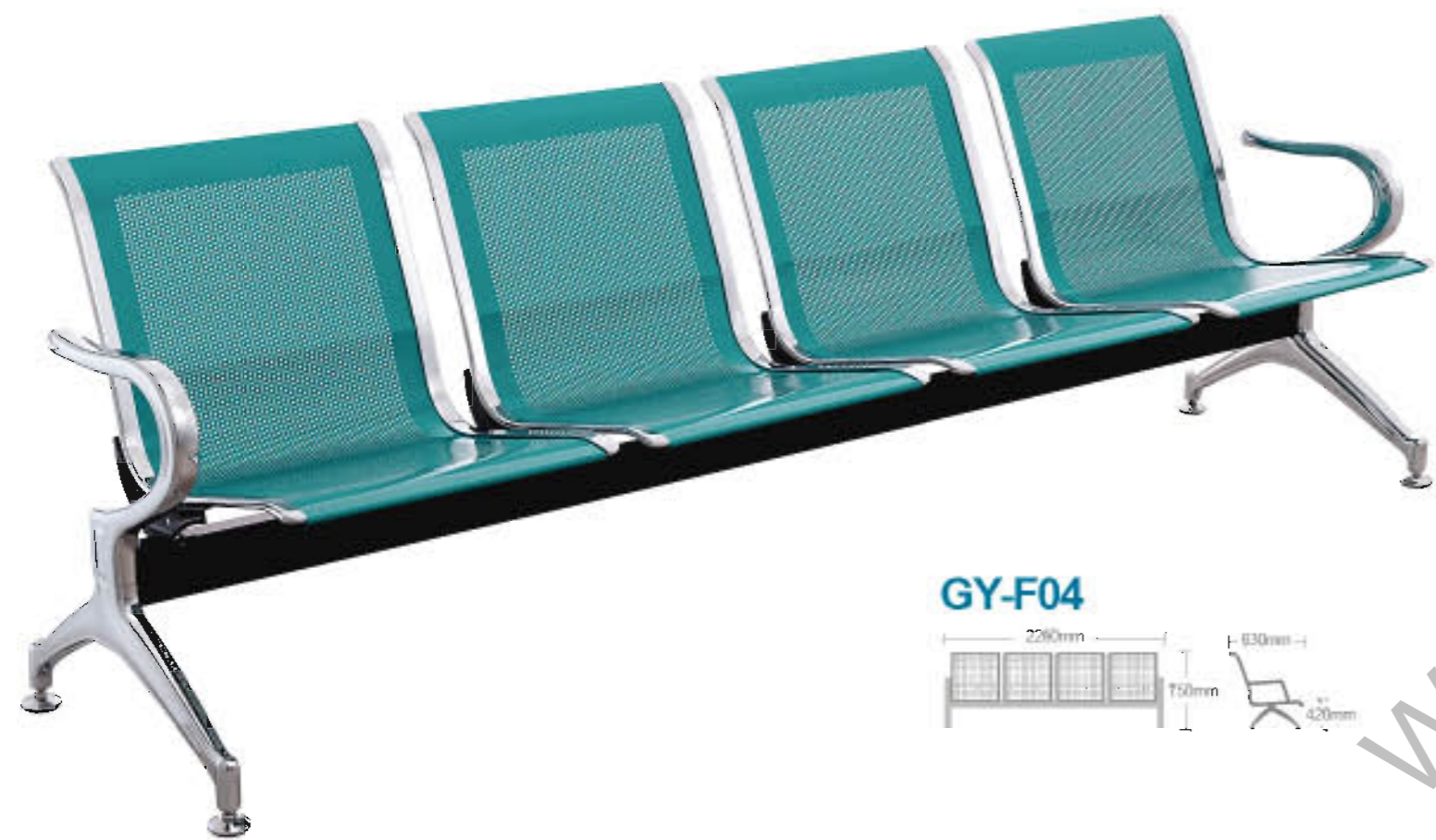
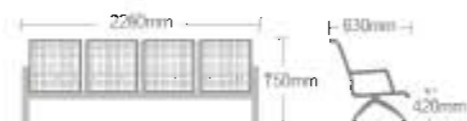
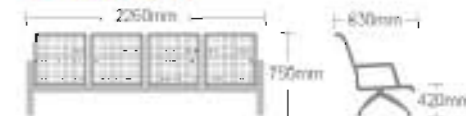
GY-F05

The creative inspiration and wisdom is the source of trend leading steady and elegant appearance comes with endless intelligence, noble and graceful quality fully demonstrates free and unrestrained styles.
引领时代之先，来自创新的灵感，稳重敦实的外表内藏无尽智慧，尊贵典雅气质尽显自如洒脱。

每一款的设计都是舍身处地为使用者着想，适用性与舒适度是一直以来绝对不可回避的思维方式。
Every design is made to suit each user. Usage and comfort are two things which will always be considered

GY-F04

GY-F04F

WANROOEMED

The creative inspiration and wisdom is the source of trend leading steady and elegant appearance comes with endless intelligence, noble and graceful quality fully demonstrates free and unrestrained styles.
引领时代之先，来自创新的灵感，精益求精的外表内就无尽智慧，尊贵典雅气质早已自如流露。

颇具吸引力的外形，别具一格的风情，最挑剔的客户在它面前也会缄默不语。
An attractive appearance and an informal style, appeal to meet the standards of the most demanding customer



GY-H01

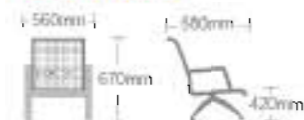

GY-H03

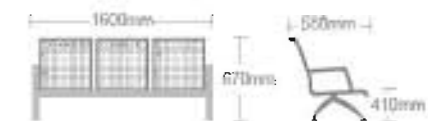

GY-H02

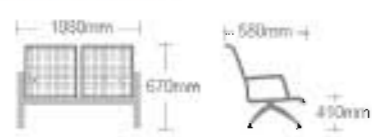

GY-H03F



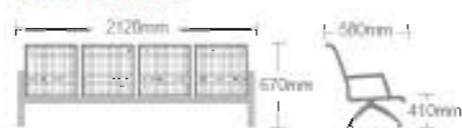

GY-H04

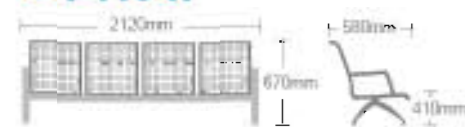
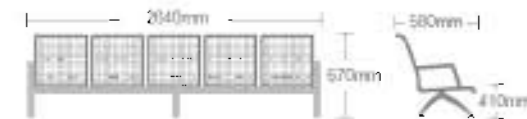
轻松随意，创思灵动。原始，物质本体的一种美丽，朴素沉静中，也有诉说的激情。当禁锢的屏障卸去时，心灵的界限，也已悄然融合。和谐，美的驿动。
The relaxed spirit the source of creation, the beauty of the material is in the primitive form, the simplicity and silence can tell emotion. Break the shackles and then you will attain a state of harmony.

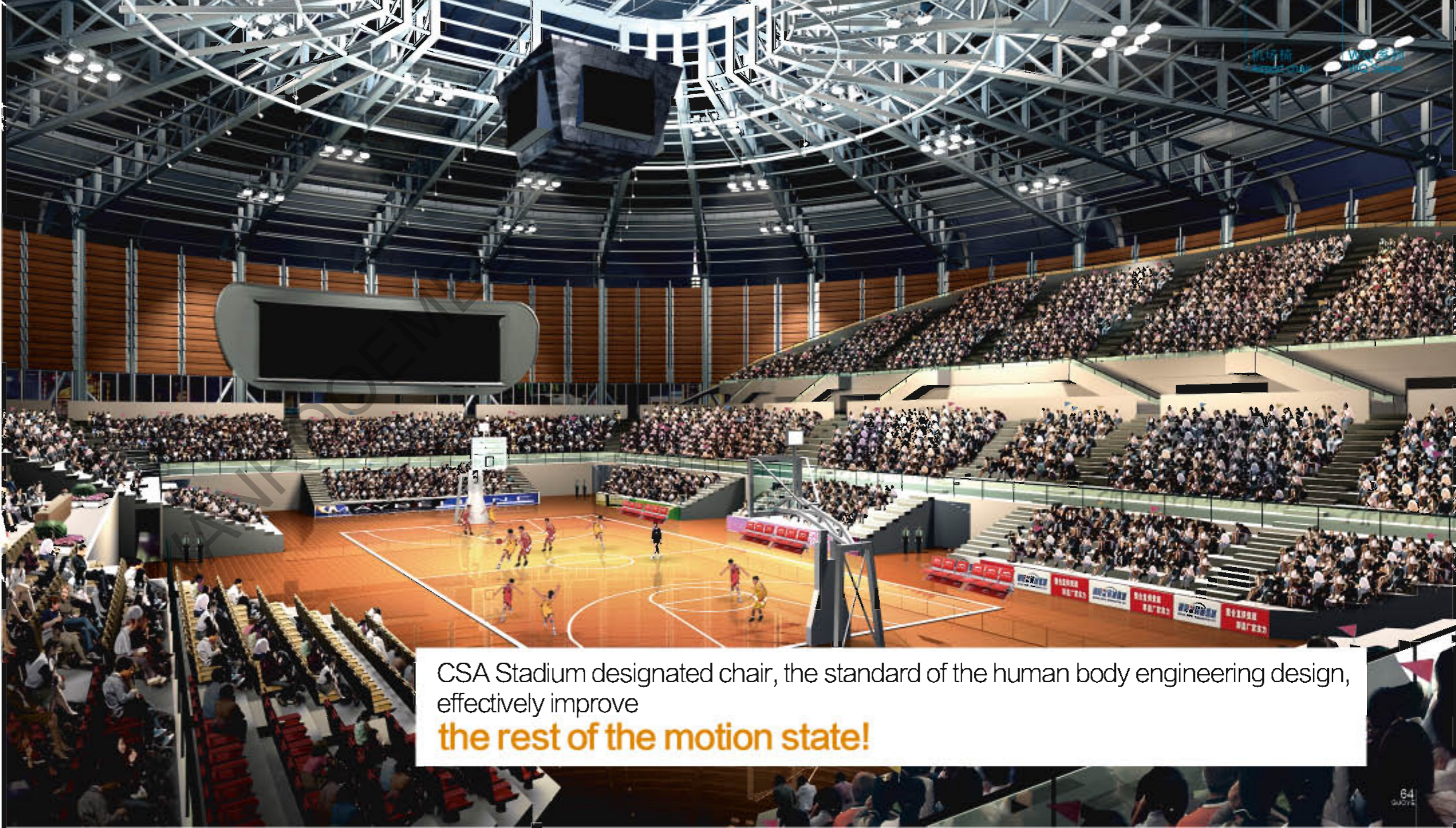

GY-H04F

GY-H05



CBA stadium designated chair
CBA 运动场 指定用椅

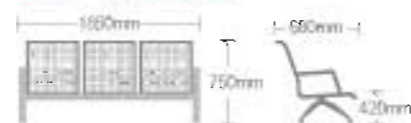
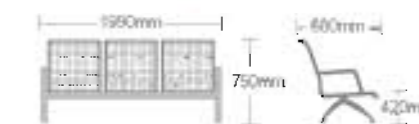

CSA Stadium designated chair, the standard of the human body engineering design, effectively improve
the rest of the motion state!

GY-WQ03F

GY-WQ03F+ 2

Armrests, Legs 扶手、脚

采用深拉钢板冲压，焊接而成，除锈处理后静电喷涂。
Uses the deep drawing steel plate ramming, after the welding becomes stain removal processing, the static electricity spraying.

Seat 座板

采用 2mm 厚冷轧板，冲孔，焊接而成，除锈处理后静电喷涂。
Uses 2mm thick Leng Zaban, the punch holes, after the welding becomes stain removal processing, the static electricity spraying.

Crossbeam 横梁

50 x 50 x 3 mm 厚钢管，喷户外漆处理。
50 x 50 x 3 mm thick steel pipe, spray coating outdoors paint powder processing.

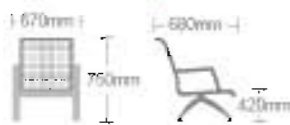
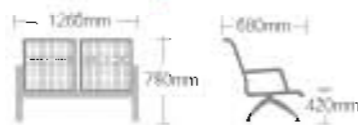
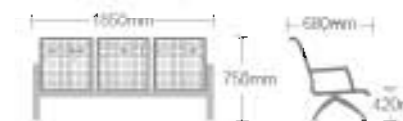
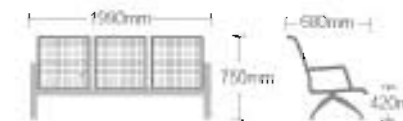
GY-WQ01

GY-WQ02

GY-WQ03

GY-WQ03+2

简单自然就是布置空间最好的手法。
Simple and nature is the best way to furnish the space.

Armrests, Legs 扶手、脚

采用深拉钢板冲压，焊接而成，除锈处理后静电喷涂。
Uses the deep drawing steel plate ramming, after the welding becomes stain removal processing, the static electricity spraying.

Seat 座板

采用 2mm 厚冷轧板，冲孔，焊接而成，除锈处理后静电喷涂。
Uses 2mm thick Leng Zaban, the punch holes, after the welding becomes stain removal processing, the static electricity spraying.

Crossbeam 横梁

50 x 50 x 3 mm 厚钢管，喷户外漆处理。
50 x 50 x 3 mm thick steel pipe, spray coating outdoors paint powder processing.



GY-WQ04

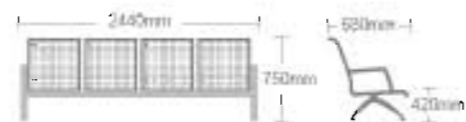

GY-X03

GY-WQ05

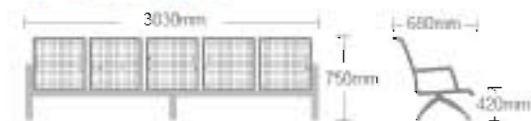

Armrests, Legs
扶手、脚

采用深拉钢板冲压，焊接而成，除锈处理后静电喷涂。
Uses the deep drawing steel plate ramming, after the welding becomes stain removal processing, the static electricity spraying.

Seat
座板

采用 2mm 厚冷扎板，冲孔，焊接而成，除锈处理后静电喷涂。
Uses 2mm thick Leng Zaban, the punch holes, after the welding becomes stain removal processing, the static electricity spraying.

Crossbeam
横梁

50 x 50 x 3 mm 厚钢管，喷涂户外漆粉处理。
50 x 50 x 3 mm thick steel pipe, spray coating outdoors paint powder processing.

GY-Y03

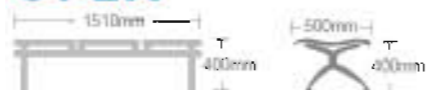

颇具吸引力的外形，别具一格的风情，最挑剔的客户在它面前也会缄默不语了。
An attractive appearance and an informal style, appeal to meet the standards of the most demanding customer.

GY-L03

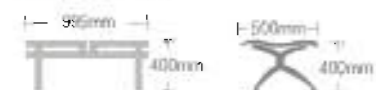
GY-L04

GY-L02

GY-L03F

GY-L05

点滴椅系列
Drips and drabs chair series

点滴椅系列
Drips and drabs chair series



GY-BD03

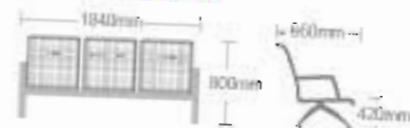

GY-BD03+2





GY-RD03
1900mm
500mm
560mm
420mm



GY-DD01
660mm
660mm
730mm
430mm



GY-DD02
1280mm
560mm
730mm
430mm

WANROOEMED



在表现形式上强调了东方的“减法”哲学和目前流行的极简风格，达到一种禅境中不失现代感的视觉表达，淡泊沉稳的色调与博大深厚的文化底蕴吻合。
Banners furniture features subtractions of oriental philosophy and popular simple style, while the its deep colour complies with broad and profound culture.

我们探索的思维不仅在现代风格里体现，而且还关注着传统经典中蕴藏的精华，力图将人们对家的热爱阐述得淋漓尽致。 We are trying to find culture essence in both modern style and classical style and expressing love to home completely.

GY-DD01A

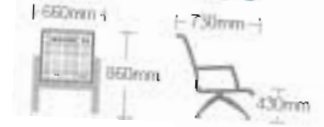

GY-DD02A

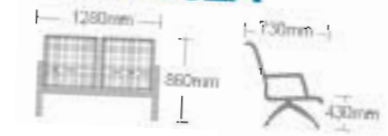

GY-DD03A

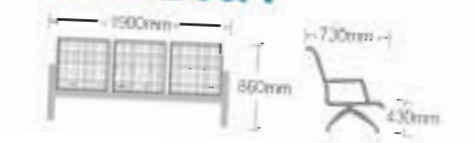

GY-DD04A



WANROOEMED

每一款的设计都是舍身处地为使用者着想，适用性与舒适度是一直以来绝对不可回避的思维方式。
Every design is made to suit each user. Usage and comfort are two things which will always be considered



GY-DD05A

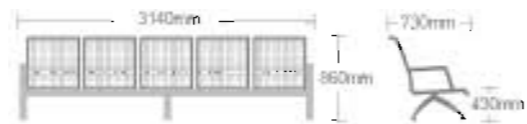

休闲、办公沙发系列 Leisure & office sofa series





GY-311A

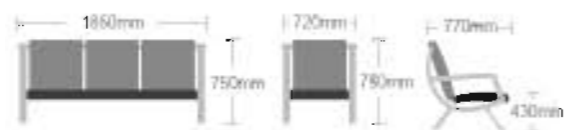

GY-311B

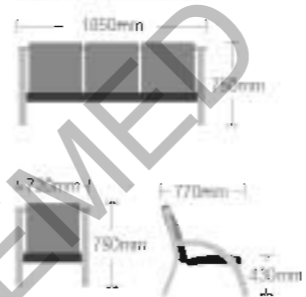

GY-311C

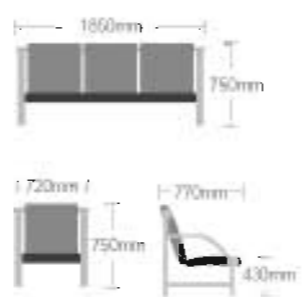



GY-311D

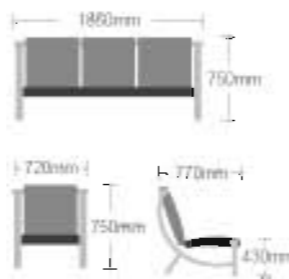

GY-311F

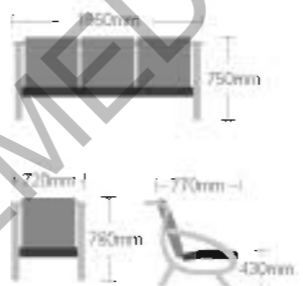

GY-311E

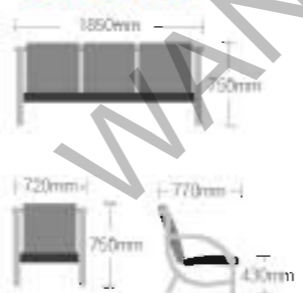

GY-311G

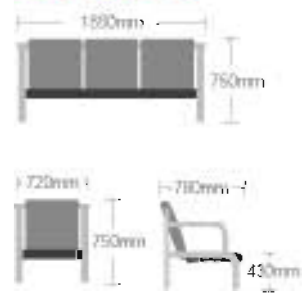

GY-321A

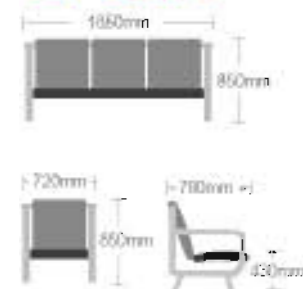

GY-321B

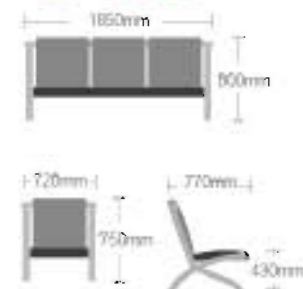

GY-321C

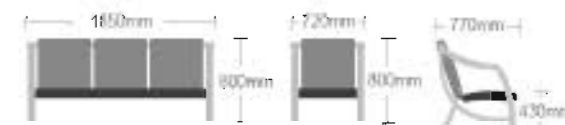

休闲、办公沙发系列
Leisure & office sofa series

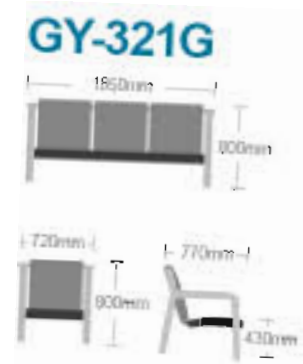

休闲、办公沙发系列
Leisure & office sofa series



GY-3210

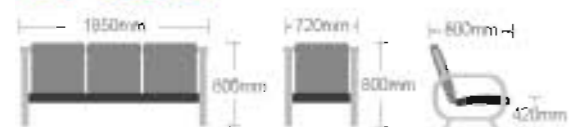

GY-321P

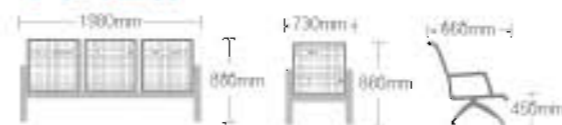

纹踏的存在，似乎都缓缓地流淌着生命，轻盈、平衡、纯净、自然，这是一个受哲思影响的简约的空间，当自然的元素运用到家具设计领域时，一个宁静平和的内部环境就成了无须语言的存在，一个虚净的空间，本身就是一种静态的呈现，却具有温暖的人性。

The vivid grain symbolizes life Which has so close relation to our life, so that we can feel that we are quite close to each other. The simple space in oriental philosophy means lightness, balance, pureness and nature. When the elements of nature are adopted in the filed of furniture design, the quiet and peaceful internal environment will be built up naturally, also of the warm humanism.

GY-321U



GY-321V

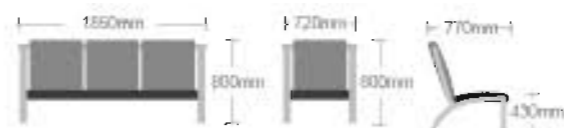

GY-XT

渴求美丽的事物，追求至佳的生活享受，是人与生俱来的天性，设计与完善我们的生活环境，格雄轩的设计师肩负此任，其设计表现对生命的热爱，超常规的意念，严谨精准的工艺，其独特风格已成为经典，具有无比的魅惑。

Aspiring to the beautiful things, longing for life enjoyment. A natural ability of mankind. Perfected living environment, Gexionxuan with you all way along, reflection of the love to life, original perspective, scientific process classical style, making the ultimate prominence

GY-600

GY-608

网板可选颜色
It is available for you to chose color



001# 闪光银 Glitter silver



002# 银灰 Silvery grey



003# 银白 Glitter silver



005# 浅蓝 Light blue



006# 蓝色 Blue



007# 大红 Scarlet



008# 枣红 Purplish red



009# 绿色 Orissa green



010# 哑光黑 Matte black



01#



02#



03#



04#



05#



06#



07#



08#



09#



10#



11#



12#



13#



14#



15#

皮可选颜色
Skin can choose color



Legs

脚

采用深拉钢板冲压、焊接而成，除锈处理后静电喷涂
Adopted deep drawing steel stamping, welding and joint, rust remove treatment and electric spraying.

Armrests

扶手

采用铝合金压铸而成，处理后静电喷涂
Adopted aluminum alloy die-casting shape, electrostatic oil spraying after treatment.

Seat, Bracket

座板、支架

采用 1.5 厚冷轧冲孔、焊接而成，除锈处理静电喷涂
Adopted 1.5 thick cold rolling punching, welding and joint, rust remove treatment and electrostatic spraying.

Crossbeam

横梁

105 x 105 x 125 x 2mm 厚冷轧板焊接而成，除锈处理后静电喷涂。
105x105x125x2mm thick cold rolled plate welded and joint, rust remove treatment and electrostatic spraying.



GY-A8301+2P

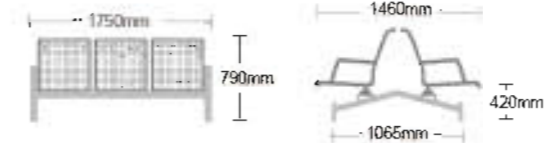

Airport chair series 机场椅系列

CONDENSATION
TECHNOLOGY,
THE QUALITY
OF
EXCELLENCE.

万容(国业)机场椅, 技术凝聚, 品质卓越。



机场椅
Airport chair

铝合金扶手、脚系列
Aluminum Alloy Armrests and Legs Series



GY-B8301F+2P

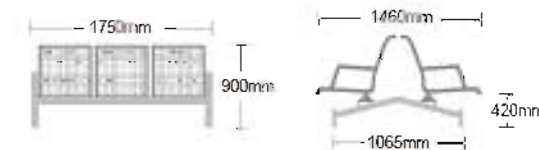

造型凝练而不枯燥，简洁而又丰盈，线条流畅而不平板，柔和而又挺拔，色彩纯正而不单调，鲜明而又沉静。它们优雅而简约的气质甚至往往令人们忽略了其完美的功能性。

The sculpture is concentrated but not boring, simple while ample. The outlines is fluent but not unmeaning, soft also straightable. The colour is pure but not bold, flaming but calm. The elegant disposition always makes person omit their perfect functions in use.



GY-A8201



GY-A8301



GY-A8401

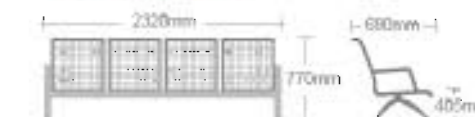

Armrests, Legs
扶手、脚

采用铝合金压铸而成，处理后静电喷涂
Adopted aluminum alloy die-casting shape, electrostatic oil spraying after treatment.

Seat, Bracket
座板、支架

采用 1.5 厚冷轧冲孔、焊接而成，除锈处理静电喷涂
Adopted 1.5 thick cold rolling punching, welding and joint, rust remove treatment and electrostatic spraying.

Crossbeam
横梁

105 mmx105 mmx125 mmx2mm 厚冷轧板焊接而成，除锈处理后静电喷涂。
105mmx105mmx125mmx2mm thick cold rolled plate welded and joint, rust remove treatment and electrostatic spraying



GY-A8501+4

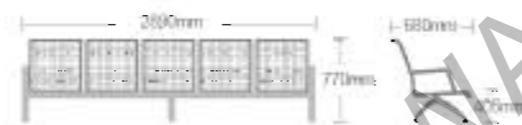

GY-A8501

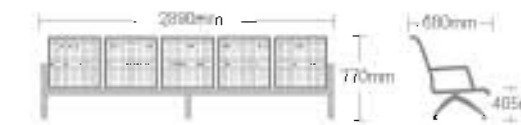

Armrests, Legs 扶手、脚

采用铝合金压铸而成，处理后静电喷涂
Adopted aluminum alloy die-casting shape, electrostatic oil spraying after treatment.

Seat, Bracket 座板、支架

采用 1.5 厚冲孔、焊接而成，除锈处理静电喷涂
Adopted 1.5 thick cold rolling punching, welding and joint, rust remove treatment and electrostatic spraying.

Crossbeam 横梁

105 mmx 105mm x 125mm x 2mm 厚冲孔板焊接而成，除锈处理后静电喷涂。
105mmx105mmx125mmx2mm thick cold rolled plate welded and joint, rust remove treatment and electrostatic spraying

以人为本的设计理念，简约的风格，精湛的工艺，大胆而富有创意的环保选材，演绎出惊讶脱俗的时尚产品，让你感受到生活的优美旋律。

Human-oriented design concept, simple style, exquisite techniques, bold and environment-friendly materials, express elegant and refined trendy products, and bring to you the wonderful tune of life

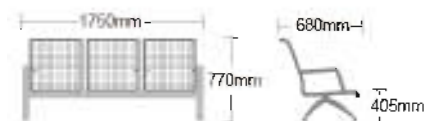
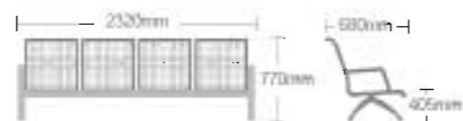
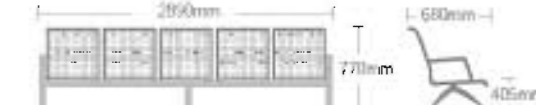
GY-A8301F

GY-A8401F

GY-A8501F

Armrests, Legs
扶手、脚

采用铝合金压铸而成，处理后静电喷涂
Adopted aluminum alloy die-casting shape, electrostatic oil spraying after treatment.

Seat, Bracket
座板、支架

采用 1.5 厚冷轧冲孔、焊接而成，除锈处理静电喷涂
Adopted 1.5 thick cold rolling punching, welding and joint, rust remove treatment and electrostatic spraying.

Crossbeam
横梁

105 mm x 105 mm x 125 mm x 2 mm 厚冷轧板焊接而成，除锈处理后静电喷涂。
105 mm x 105 mm x 125 mm x 2 mm thick cold rolled plate welded and joint, rust remove treatment and electrostatic spraying